

DRY BATTERY

DRY | CONVENTIONAL

REF BB7L-B



12V VOLTAGE - V

85A CCA - A

8.4Ah CAPACITY - Ah (20Hr)

8Ah CAPACITY - Ah (10Hr)

TECHNOLOGY

- Lead acid dry charged construction (absorbed acid)
- No acid in cells, must be filled with acid before use
- 6 & 12V batteries

FEATURES

- Upright installation only
- Has to be checked periodically and refilled with water if necessary
- Internal gas emission through venting hole
- Handle with care to prevent acid spillage
- Regular life duration
- Does not need to be recharged while stocked

UPGRADE FOR

-

WEIGHT

Battery (with acid) : Approx 2.82kg

MOUNTING ANGLE

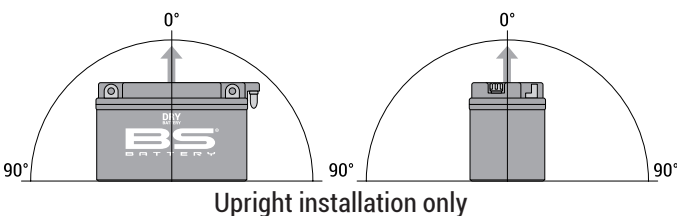

DIMENSIONS

Length (A) : 135±2mm
 Width (B) : 75±2mm
 Container height : 133±2mm
 Total height (C) : 133±2mm

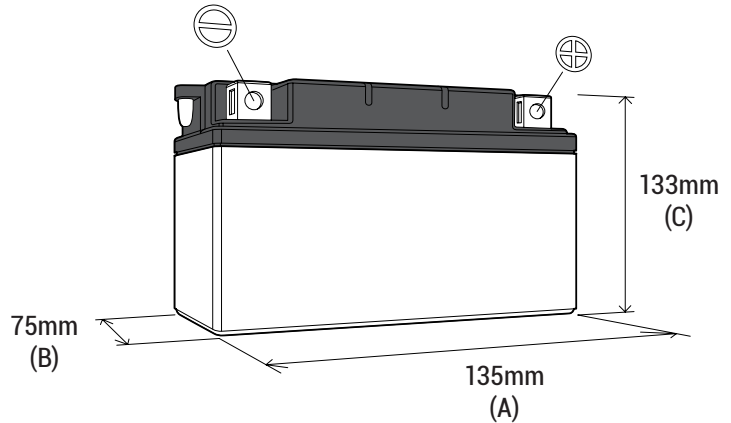

TERMINALS

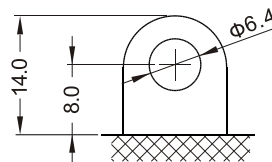

FRONT

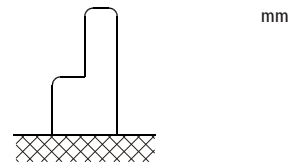

SIDE

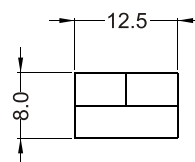

TOP